

# 使用说明书

## Operation instruction

# H63 系列

## SERIES

### 直驱上下复合送料自动剪线平缝机

#### DIRECT DRIVE SINGLE NEEDLE TOP AND BOTTOM FEEDING LOCKSTITCH SEWING MACHING WITH AUTO TRIMMER

操作说明 (Description for removal and handling)

1. 拆卸六角螺母 1 并取下轴套螺母
2. 拆卸六角螺母 1 并取下轴套螺母
3. 拆卸六角螺母 1 并取下轴套螺母

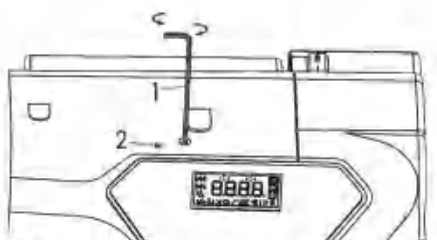

### 1. 机器简介 Brief introduction

本系列直驱上下复合送料自动剪线平缝机，采用最新式送料机构，送料平稳，缝制精度高，使用寿命长。本机采用最新式送料机构，送料平稳，缝制精度高，使用寿命长。本机采用最新式送料机构，送料平稳，缝制精度高，使用寿命长。

### 2. 主要技术参数 Main specifications

品牌	爱丽斯
型号	2000H129
最大针距	4.0mm
送料速度	2700r/min
送料行程	3.5-5.5mm
送料精度	±0.1mm
送料方式	直驱式送料
送料速度	2700r/min
送料精度	±0.1mm
送料方式	直驱式送料



### 4. 安装脚踏 (图2) Installing the knee lifter (Fig. 2)

1. 插入脚踏在提升杆上
2. 将脚踏插入提升杆孔中

### 5. 调整脚踏位置 (图3) Adjusting the knee lifter (Fig. 3)

1. 松开脚踏位置调节螺钉
2. 将脚踏移动到合适位置
3. 拧紧脚踏位置调节螺钉

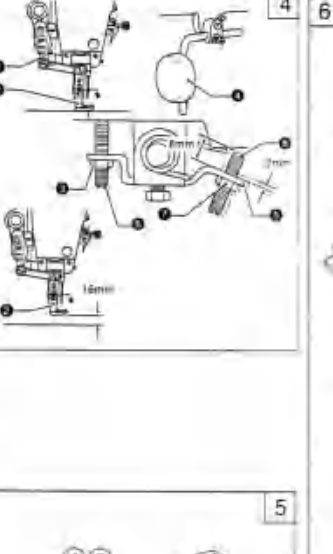

### 6. 调整脚踏位置 (图1) Adjusting knee lifter (Fig. 1)

1. 松开脚踏位置调节螺钉
2. 将脚踏移动到合适位置
3. 拧紧脚踏位置调节螺钉

### 8. 试车 (图6) Test operation (Fig. 6)

首次使用前，请先进行试车。将脚踏移动到合适位置，然后进行试车。试车时，请观察脚踏的升降是否正常。试车时，请观察脚踏的升降是否正常。

### 9. 安装机针 (图7) Installing the needle (Fig. 7)

1. 将机针插入机针孔中
2. 将机针插入机针孔中

### 10. 安装机针 (图8) Installing the needle (Fig. 8)

1. 将机针插入机针孔中
2. 将机针插入机针孔中

### 11. 安装机针 (图9) Installing the needle (Fig. 9)

1. 将机针插入机针孔中
2. 将机针插入机针孔中

### 12. 穿底线 (图10) Threading the bobbin thread (Fig. 10)

1. 将底线穿入底线孔中
2. 将底线穿入底线孔中

### 13. 穿面线 (图11) Threading the needle thread (Fig. 11)

1. 将面线穿入面线孔中
2. 将面线穿入面线孔中

### 14. 调整针距 (图12) Adjusting the stitch length (Fig. 12)

1. 调整针距调节螺钉
2. 调整针距调节螺钉

### 15. 缝边及倒缝 (图13) Sewing and backstitching (Fig. 13)

1. 按下缝边按钮
2. 按下缝边按钮

### 16. 调节线的张力 (图14) Adjusting the thread tension (Fig. 14)

1. 调整线的张力
2. 调整线的张力

### 17. 调整脚踏压力 (图15) Adjusting the presser foot pressure (Fig. 15)

1. 调整脚踏压力
2. 调整脚踏压力

### 18. 调节剪线后送线的长度 (图16) Adjusting the trailing length after thread trimming (Fig. 16)

1. 调整剪线后送线的长度
2. 调整剪线后送线的长度

### 19. 调节线张力 (图17) Adjusting the thread tension (Fig. 17)

1. 调整线张力
2. 调整线张力

### 20. 调节剪线高度 (图18) Adjusting the thread trim height (Fig. 18)

1. 调整剪线高度
2. 调整剪线高度

### 21. 调节脚踏高度 (图19) Adjusting the presser foot height (Fig. 19)

1. 调整脚踏高度
2. 调整脚踏高度

### 22. 调节脚踏高度 (图20) Adjusting the presser foot height (Fig. 20)

1. 调整脚踏高度
2. 调整脚踏高度

### 23. 调节脚踏高度 (图21) Adjusting the presser foot height (Fig. 21)

1. 调整脚踏高度
2. 调整脚踏高度

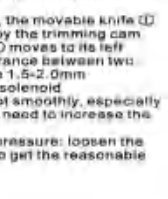
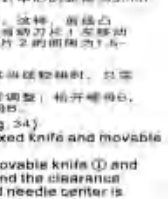
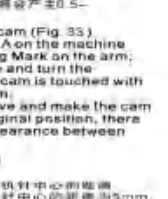
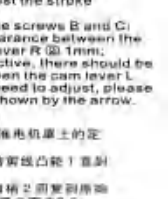
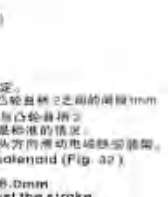
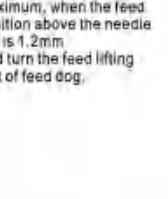
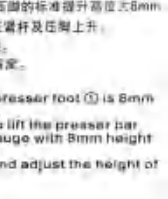
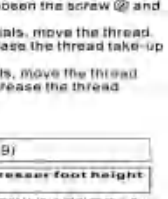
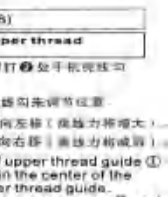
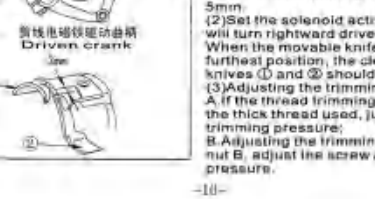
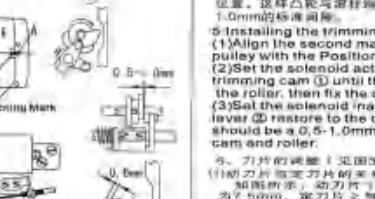
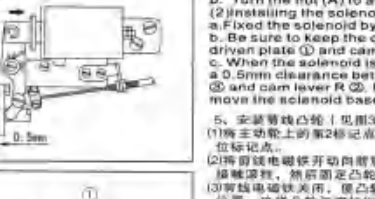
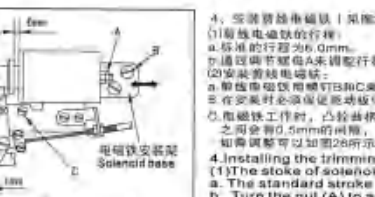
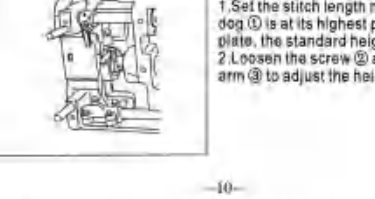
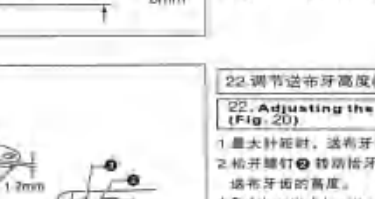
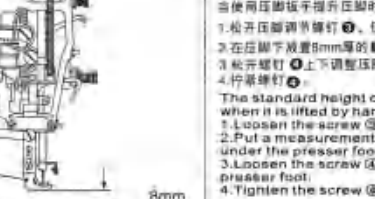
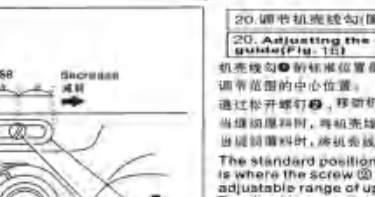
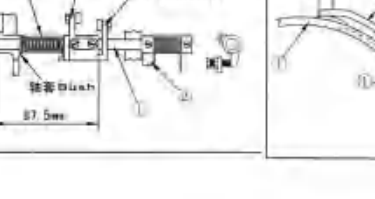
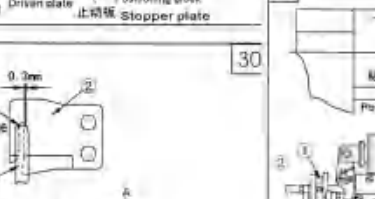
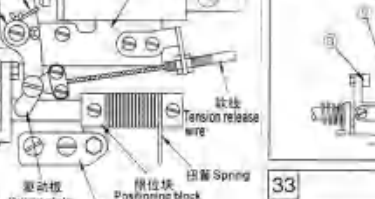
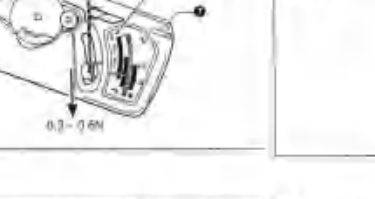
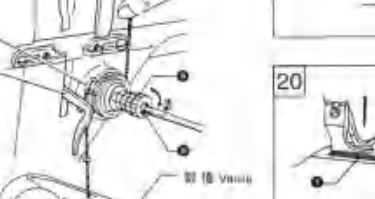
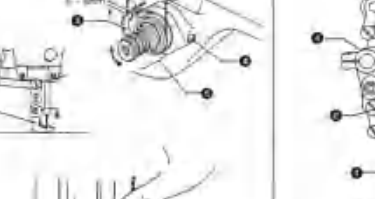
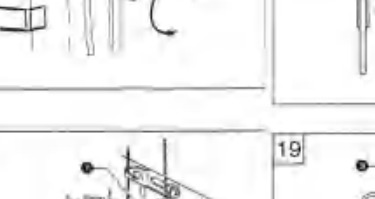
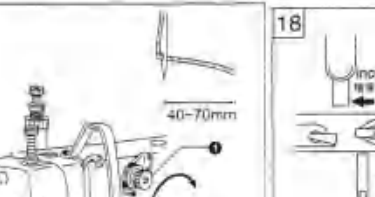
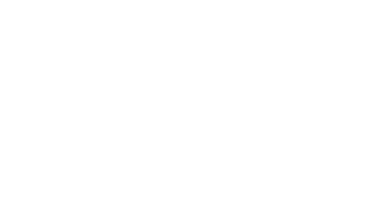
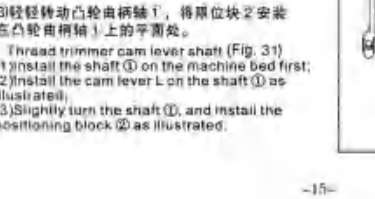
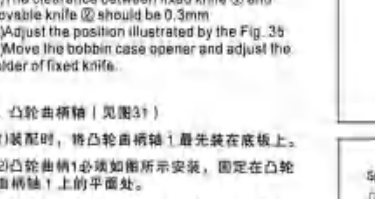
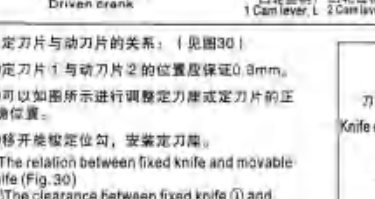
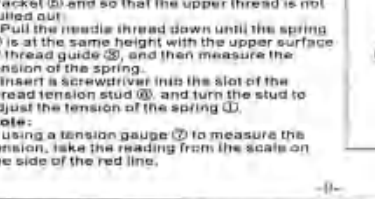
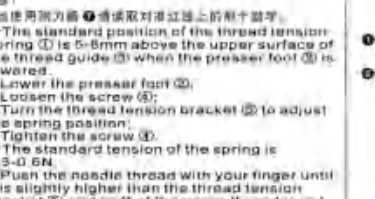
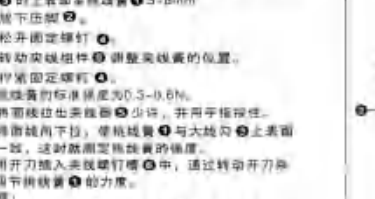
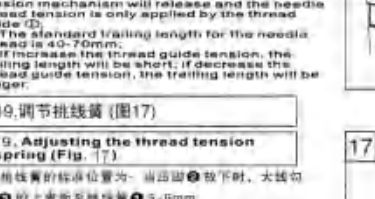
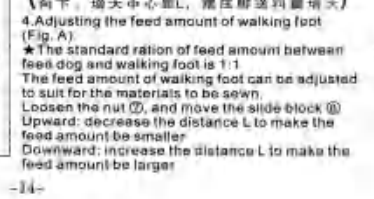
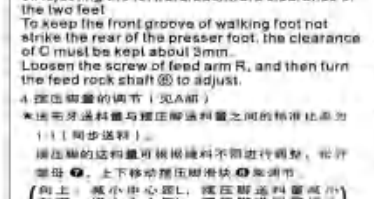
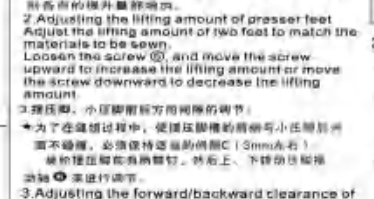
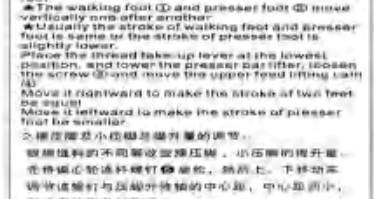
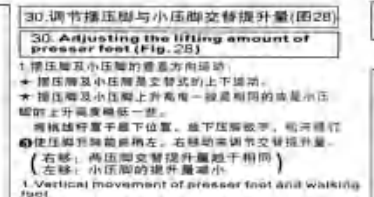
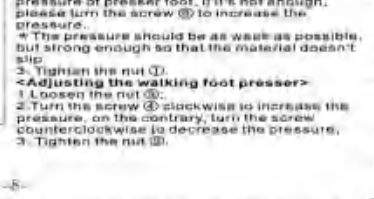
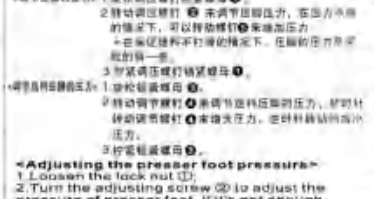
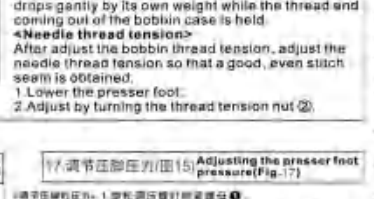
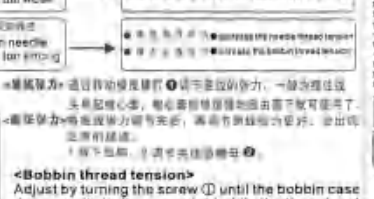
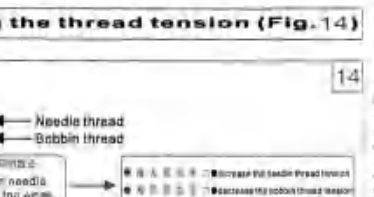
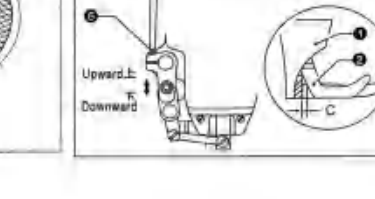
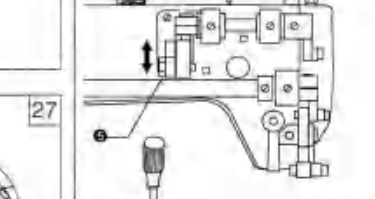
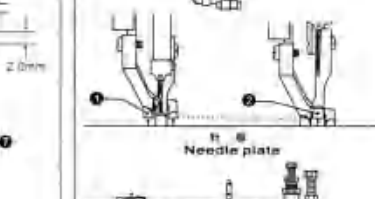
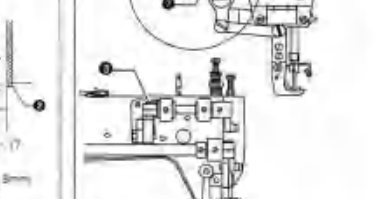
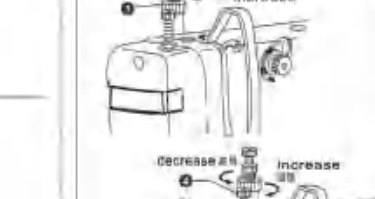
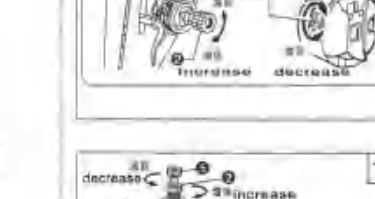
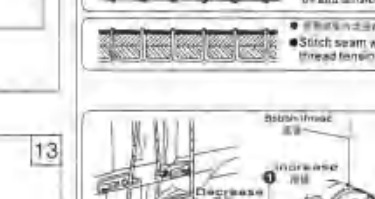
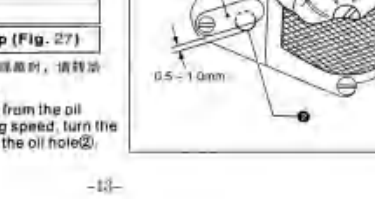
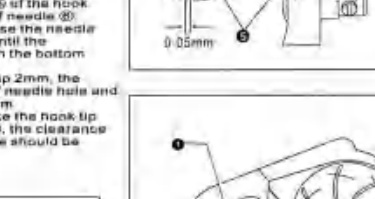
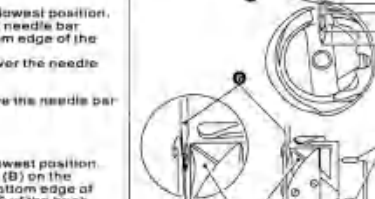
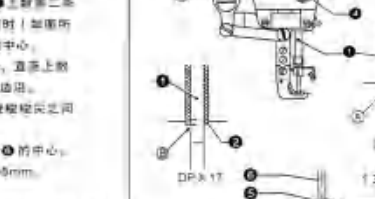
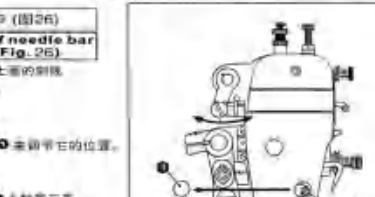
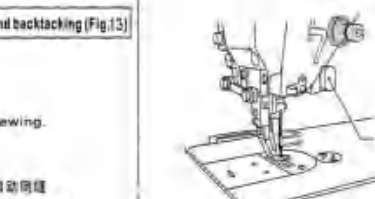
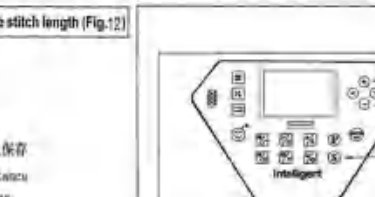
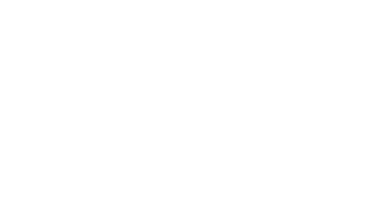
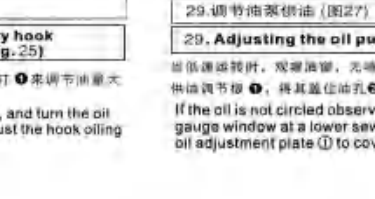
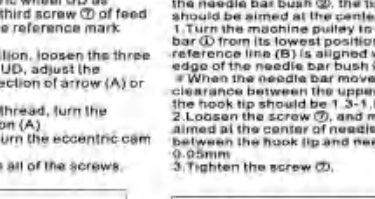
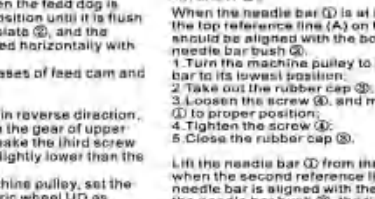
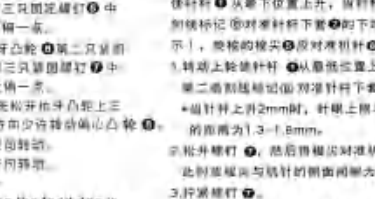
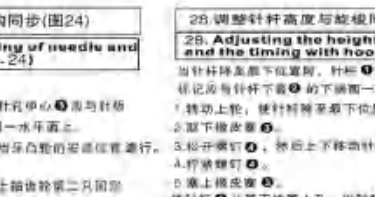
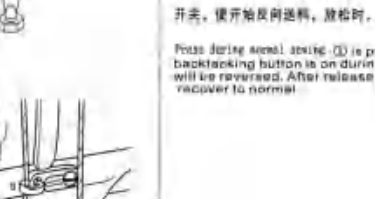
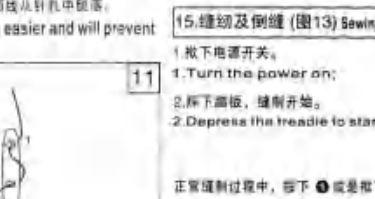
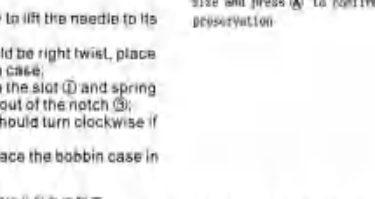
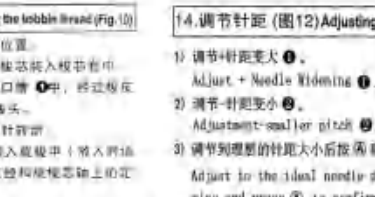
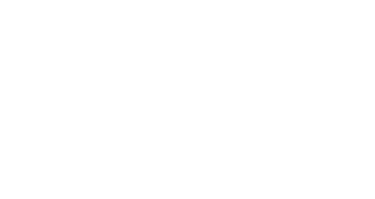
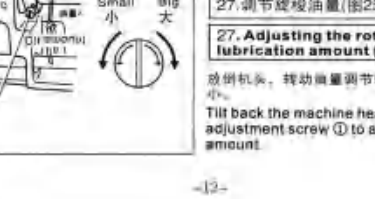
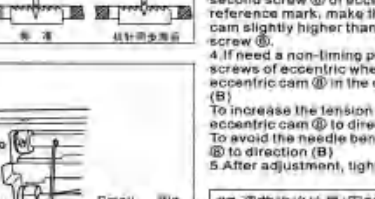
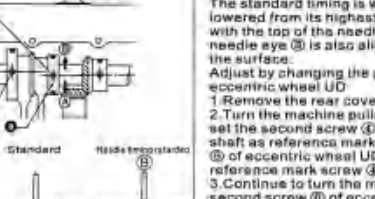
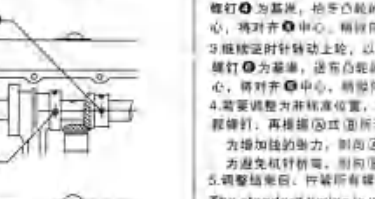
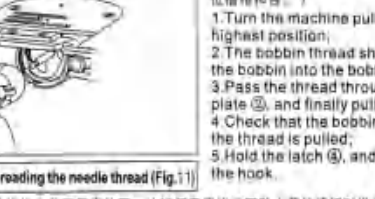
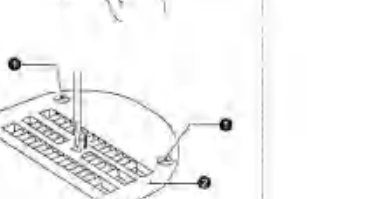
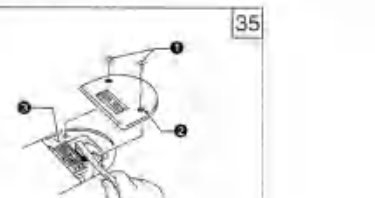
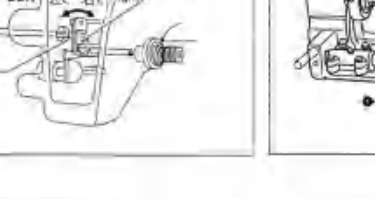
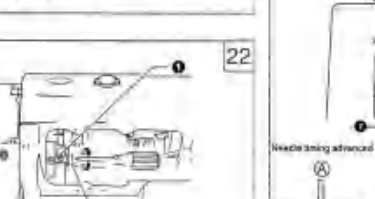
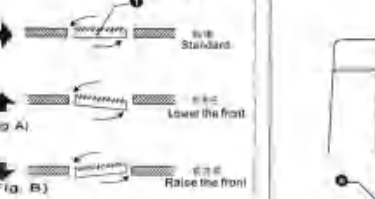
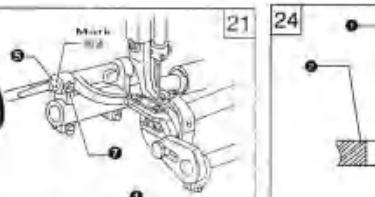
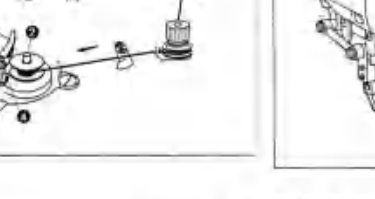
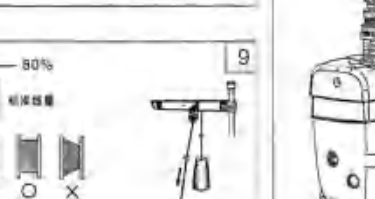
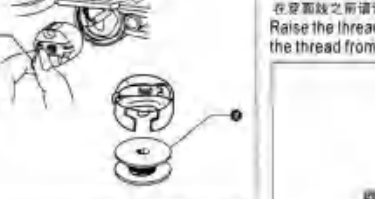
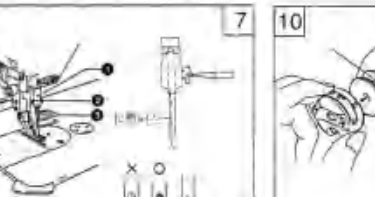

### 32. 清洁 (图35) 38. Clean (Fig. 35)

1. 清洁脚踏
2. 清洁脚踏

### 3. 清洁脚踏 (图35) 38. Clean (Fig. 35)

1. 清洁脚踏
2. 清洁脚踏

### 4. 清洁脚踏 (图35) 38. Clean (Fig. 35)

1. 清洁脚踏
2. 清洁脚踏

### 5. 清洁脚踏 (图35) 38. Clean (Fig. 35)

1. 清洁脚踏
2. 清洁脚踏

### 6. 清洁脚踏 (图35) 38. Clean (Fig. 35)

1. 清洁脚踏
2. 清洁脚踏

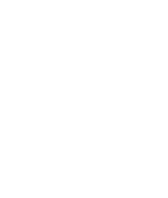
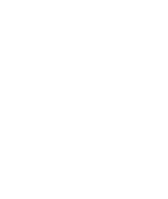
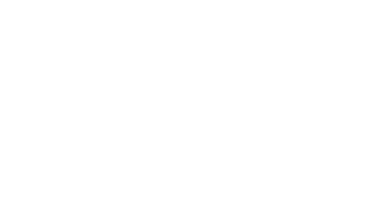
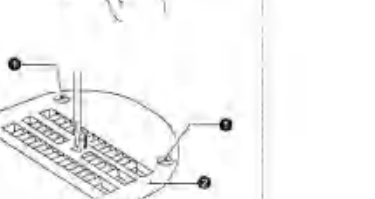
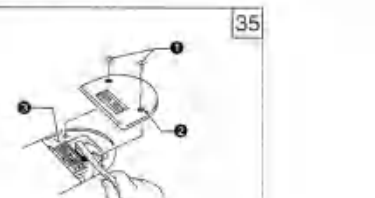



# H63系列 SERIES

## 直驱上下复合送料自动剪线平缝机 DIRECT DRIVE SINGLE NEEDLE TOP AND BOTTOM FEEDING LOCKSTITCH SEWING MACHIN WITH AUTO TRIMMER

# 零件手册 Parts Manual

### 2. 机壳部件 2. 机壳部件

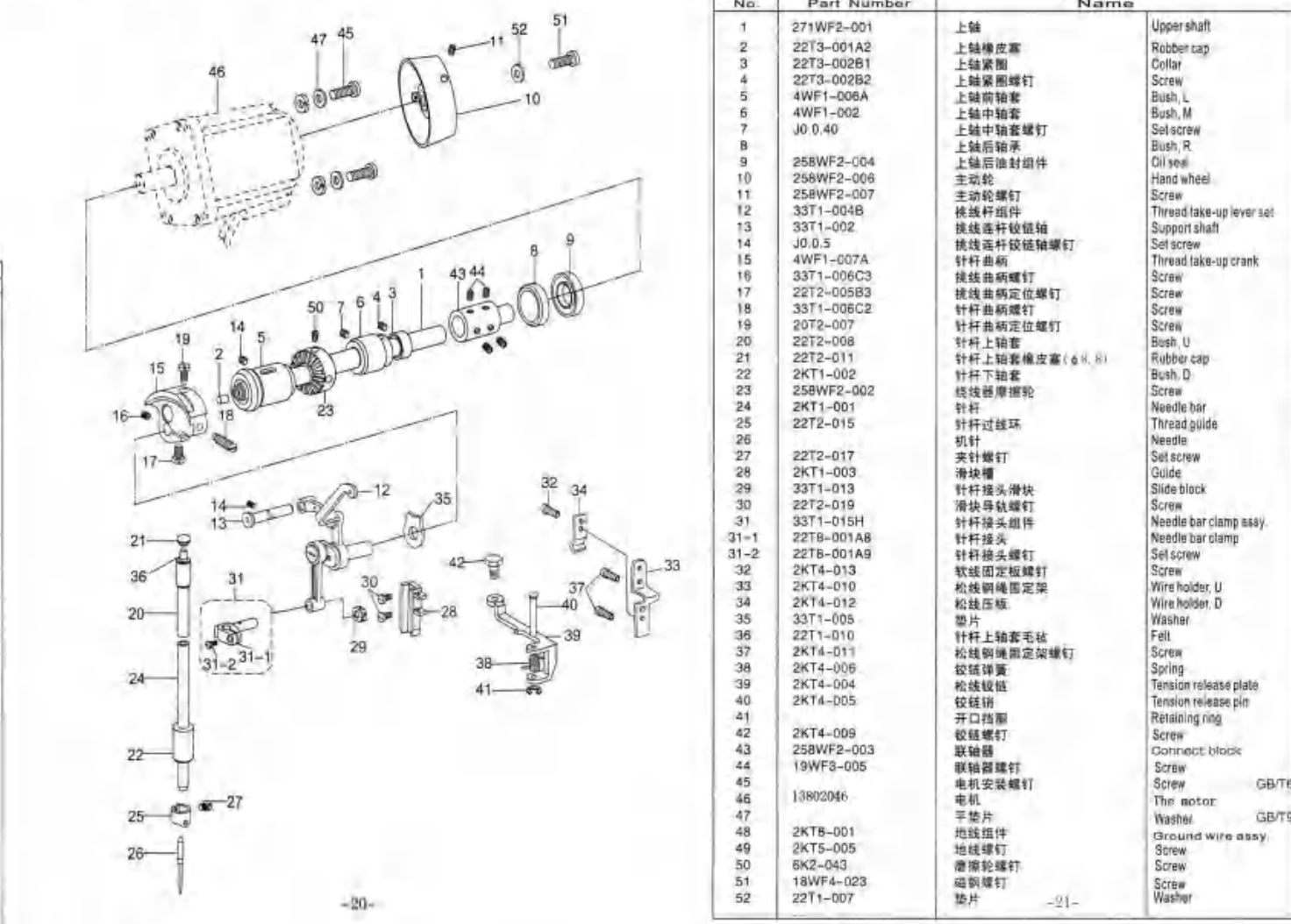

### 2. 机壳部件 2. 机壳部件

序号 No.	图号 Part Number	零件名称 Name	数量 Qty
1	13W1001	面盖	1
2	7WF4-004	面盖螺钉	3
3	22T1-003C5	面盖螺钉	3
4	22T1-011	面盖螺钉	3
5	38T2-006D	小轴螺母	1
6-2	38T2-006C1	小轴螺母	1
6-3	38T2-006C2	小轴螺母	1
6-4	38T2-006C3	小轴螺母	1
6-5	38T2-006D4	小轴螺母	1
7	22T1-004	小轴螺母	1
8	7WF4-015	下轴盖	1
9	33T4-008C	面盖螺母	1
9-1	22T1-012F1	面盖螺母	1
9-2	22T1-012F2	面盖螺母	1
9-3	22T1-012F3	面盖螺母	1
9-4	22T1-012F4	面盖螺母	1
9-5	22T1-012F5	面盖螺母	1
9-6	22T1-012F6	面盖螺母	1
9-7	22T1-012F7	面盖螺母	1
9-8	22T1-012F8	面盖螺母	1
9-9	22T1-012F9	面盖螺母	1
9-10	22T1-012F10	面盖螺母	1
9-11	22T1-012F11	面盖螺母	1
10	1KT1-003	面盖螺母	1
11	1KT1-003	面盖螺母	1
12	22T2-004	面盖螺母	1
13	38T2-005	面盖螺母	1
14	38T2-005	面盖螺母	1
15	38T2-005	面盖螺母	1
16	2KT4-003	面盖螺母	1
17	7WF4-006	面盖螺母	1
18	7WF4-006	面盖螺母	1
19	7WF4-006	面盖螺母	1
20	7WF4-013	面盖螺母	1
21	1380102	面盖螺母	1
22	1380103	面盖螺母	1
23	1380103	面盖螺母	1
24-1	7WF4-005	面盖螺母	1
24-2	56WF1-023	面盖螺母	1
24-3	60T1-013F2	面盖螺母	1
24-4	60T1-013F3	面盖螺母	1
25	2KT2-003	面盖螺母	1
26	22T1-020	面盖螺母	1
27	199WF5-012	面盖螺母	1
28	92WF2-027	面盖螺母	1
29	92WF2-043	面盖螺母	1
30	36WF2-031	面盖螺母	1
31	25WF1-095	面盖螺母	1
32	19WF1-019	面盖螺母	1
33	1380103	面盖螺母	1
34	1380103	面盖螺母	1
35	1380103	面盖螺母	1
36	1380103	面盖螺母	1

### 1. 机壳部件

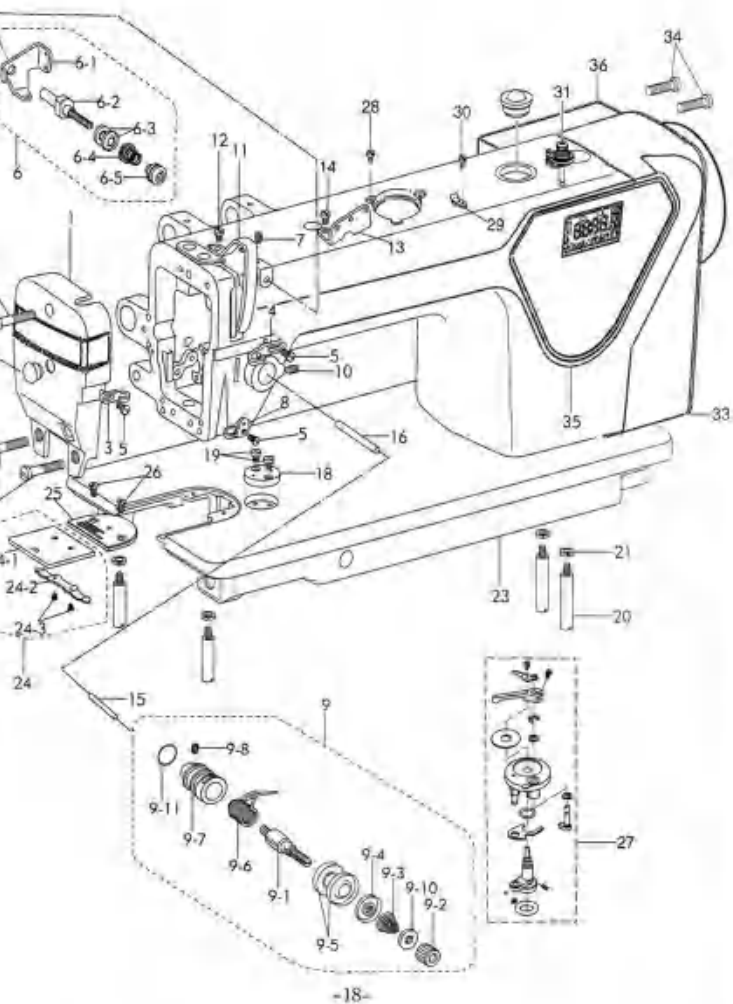

### 4. 送料部件

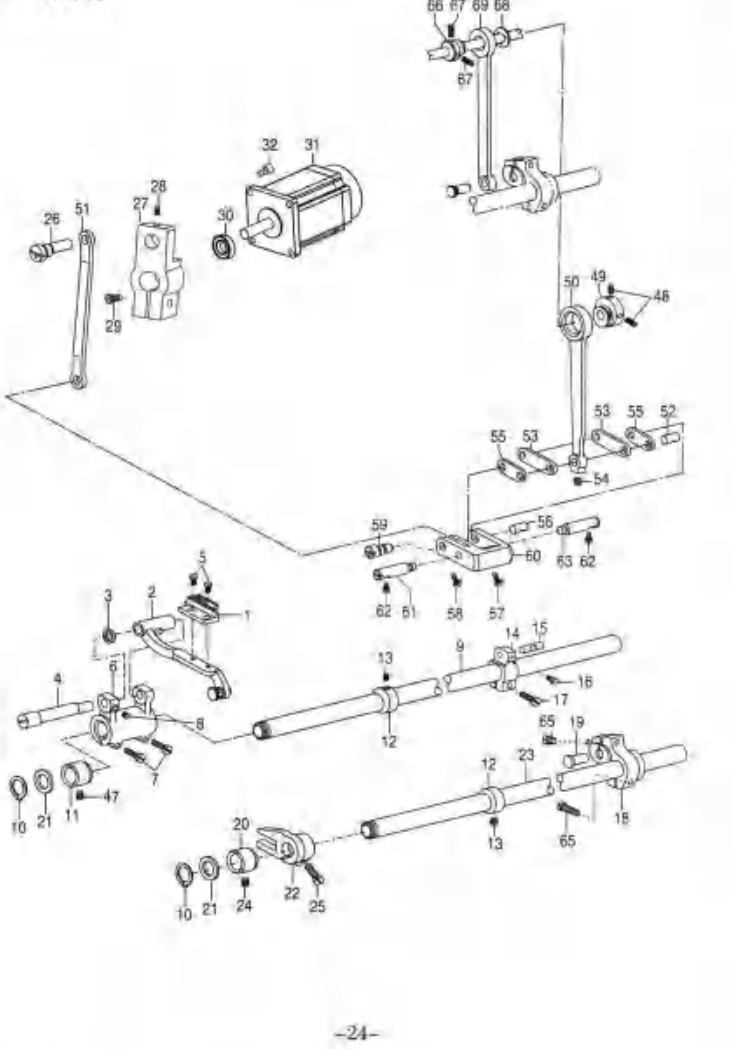

### 6. 旋梭部件

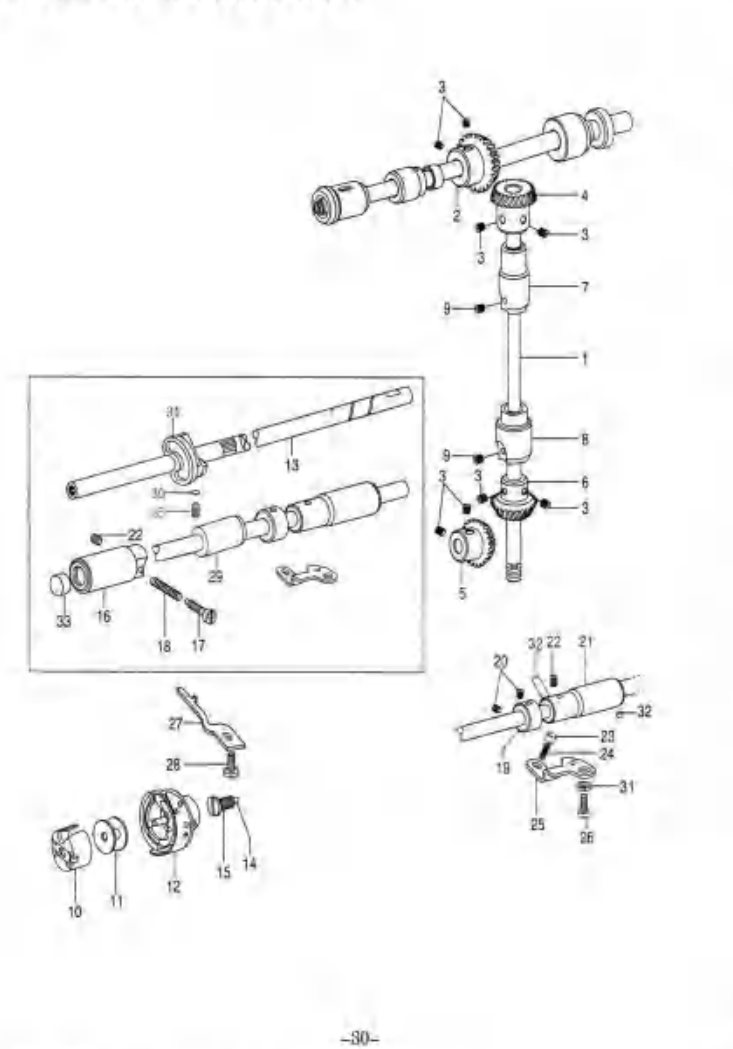

### 9. 倒缝部件

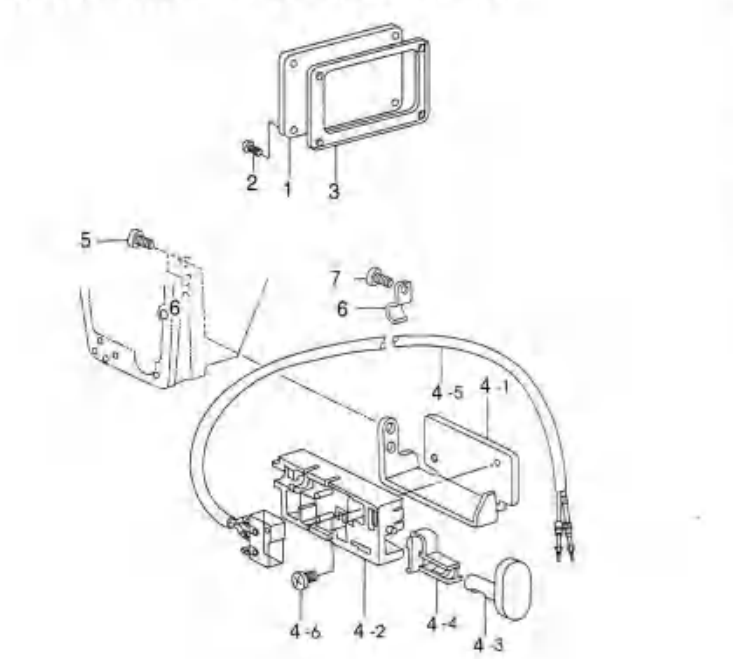

### 4. 送料部件

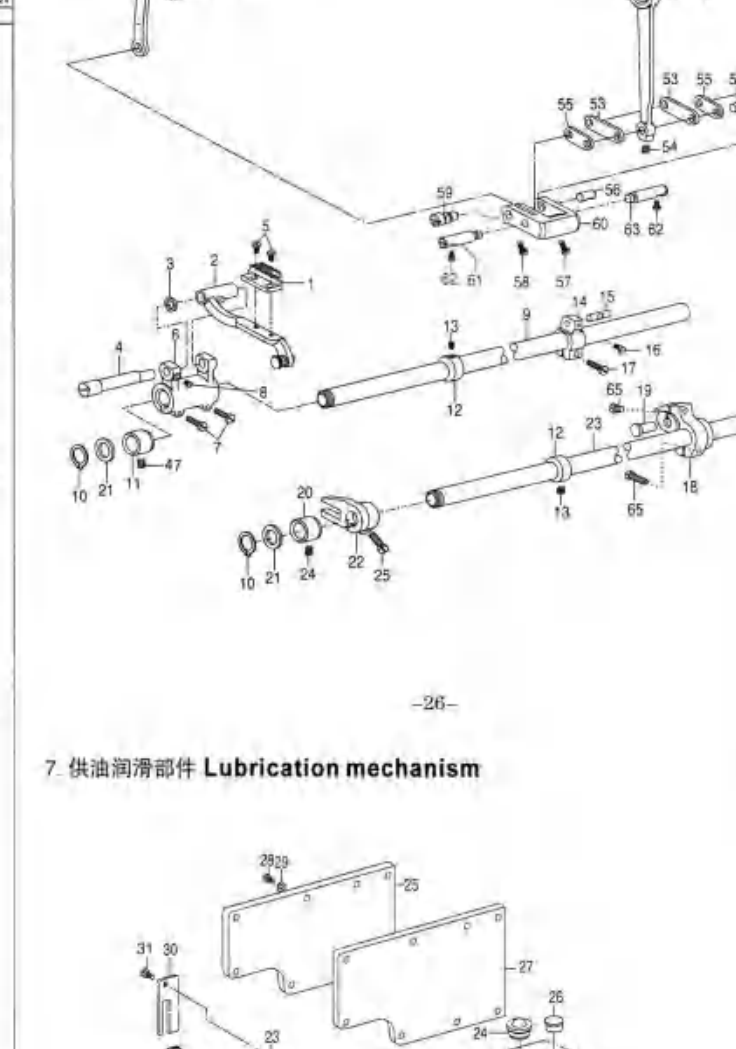

### 7. 供油润滑部件

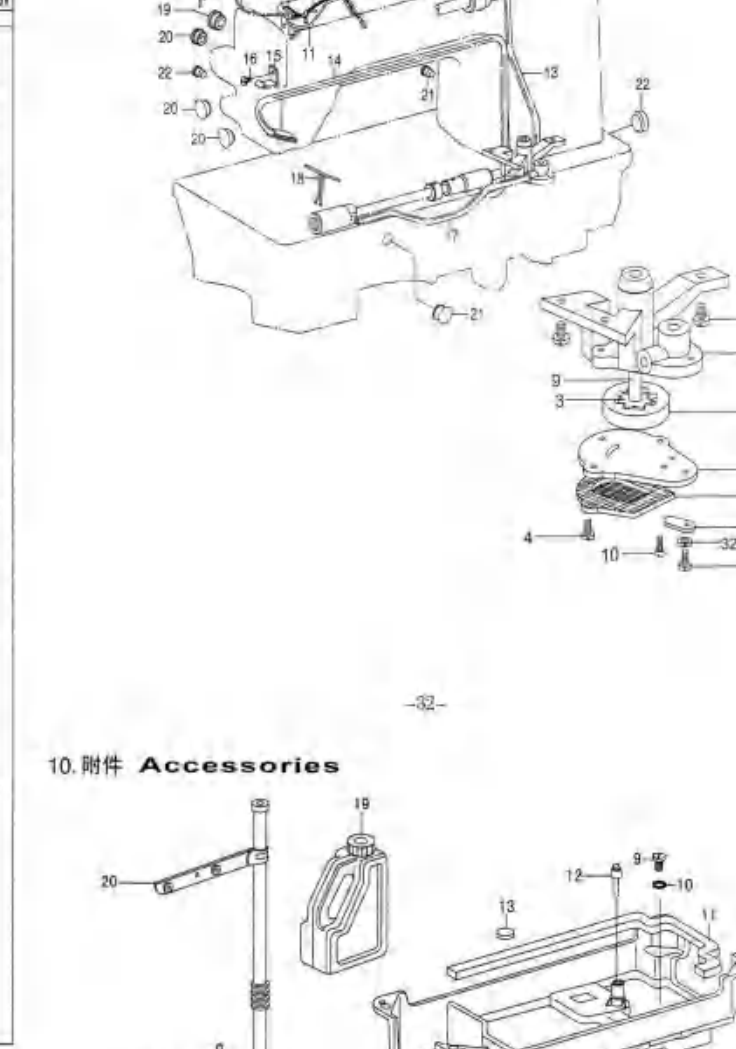

### 10. 附件

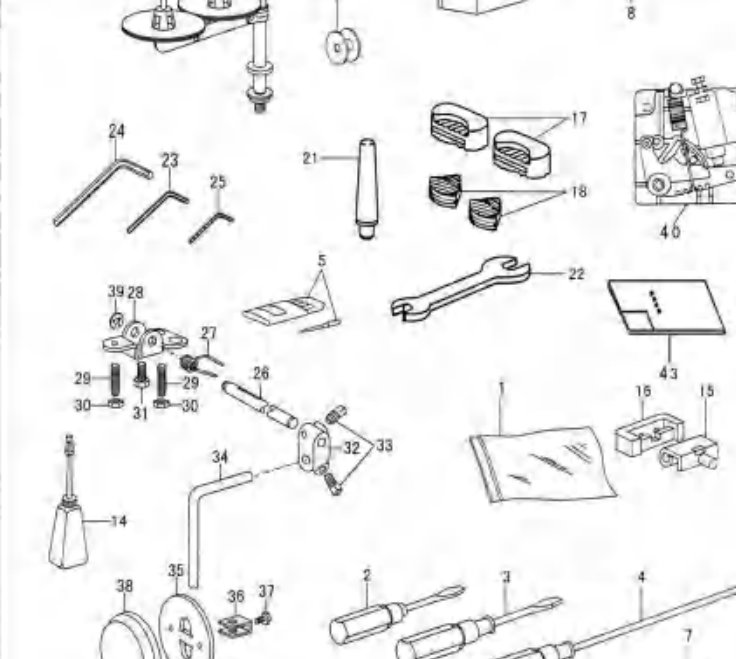

### 2. 机壳部件 2. 机壳部件

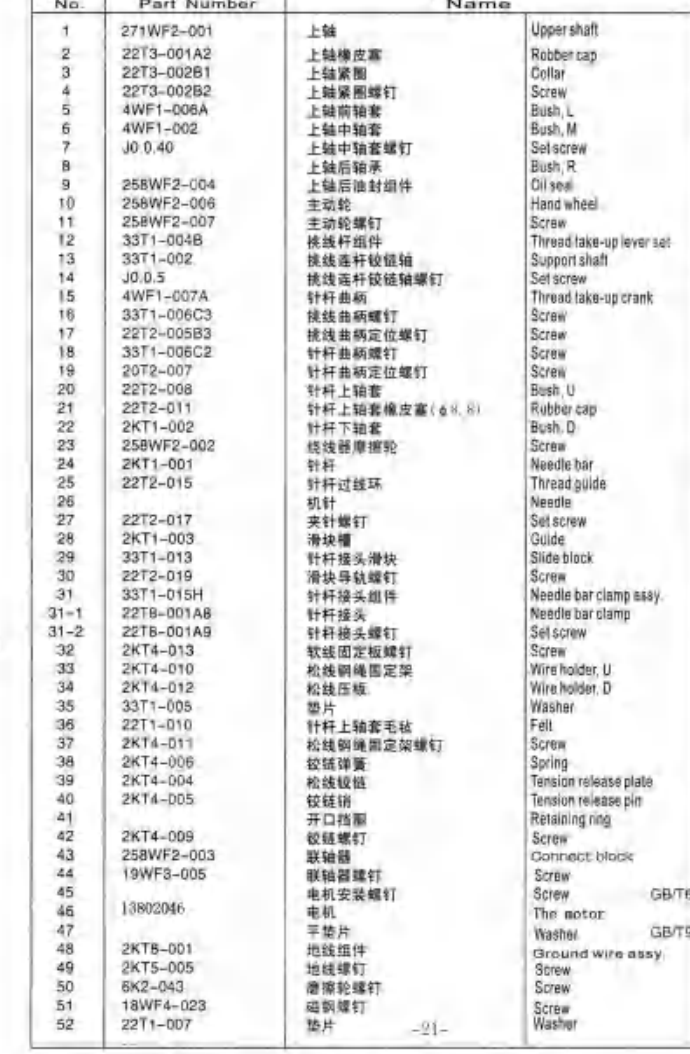

### 4. 送料部件



### 7. 供油润滑部件



### 10. 附件



### 3. 压脚部件 3. 压脚部件

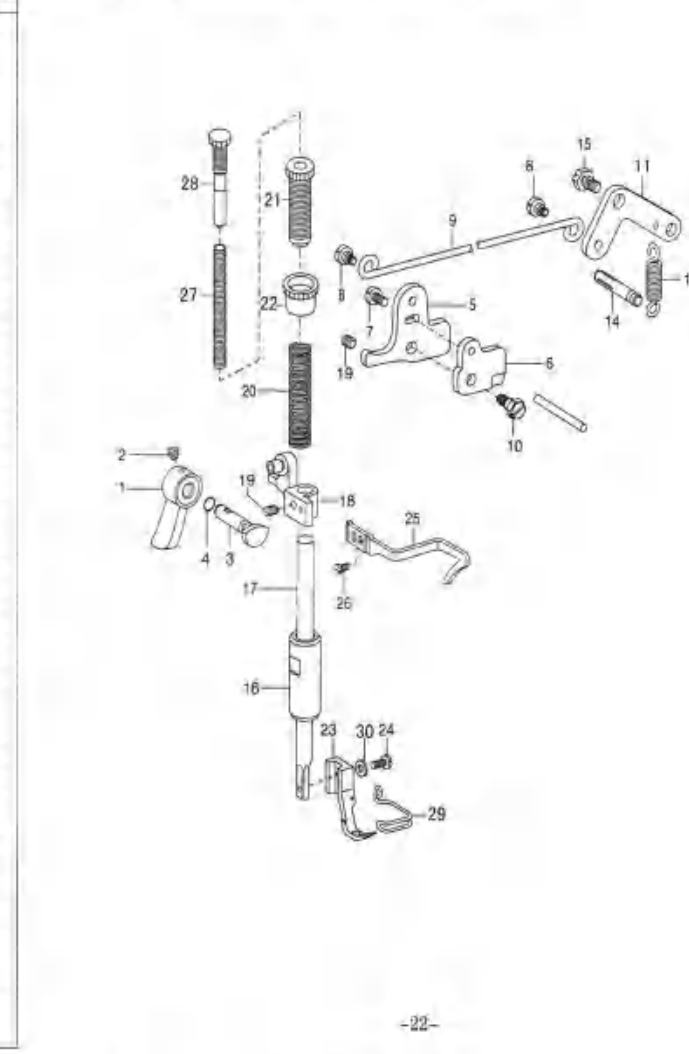

### 5. 上送料部件

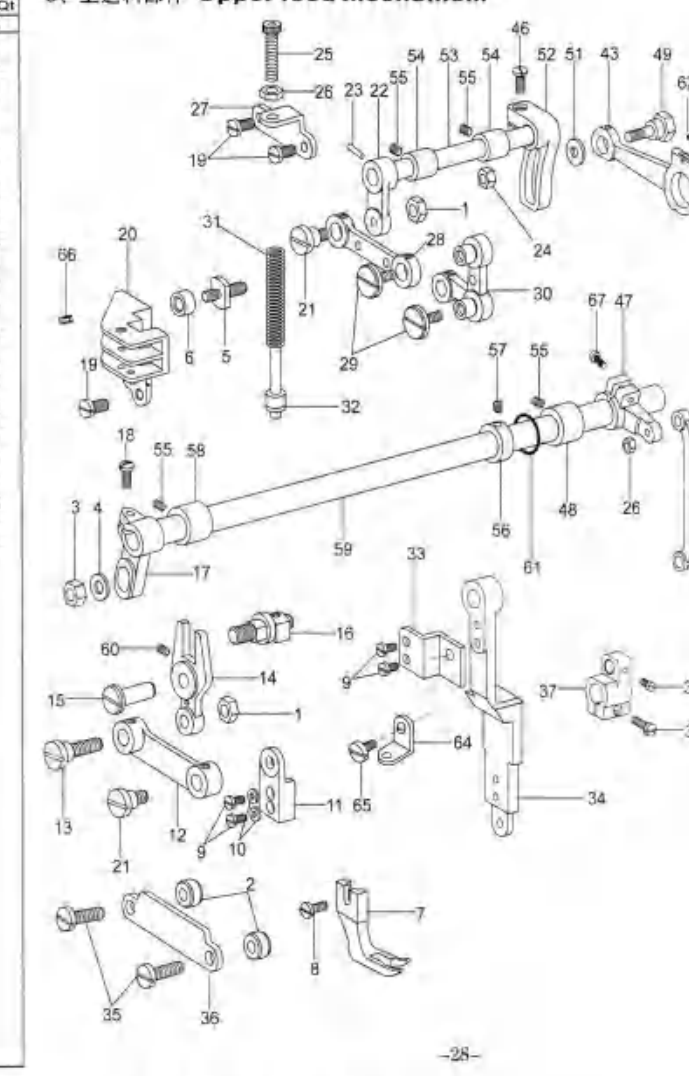

### 8. 剪线部件

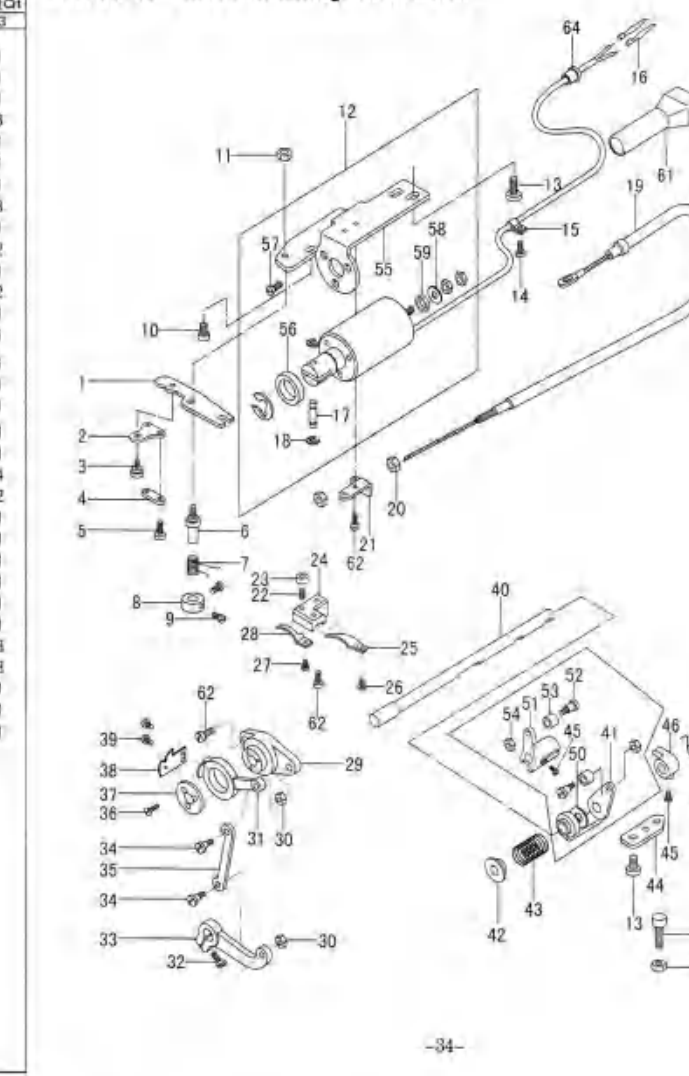

### 11. H63-C-TW 专用部件

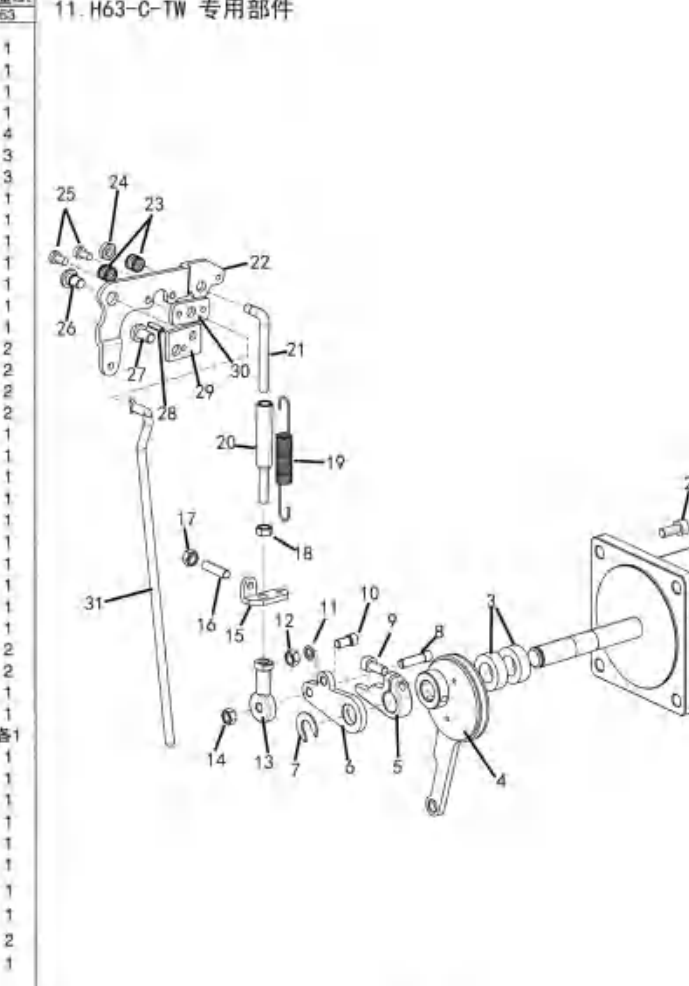

### 3. 压脚部件 3. 压脚部件



### 5. 上送料部件

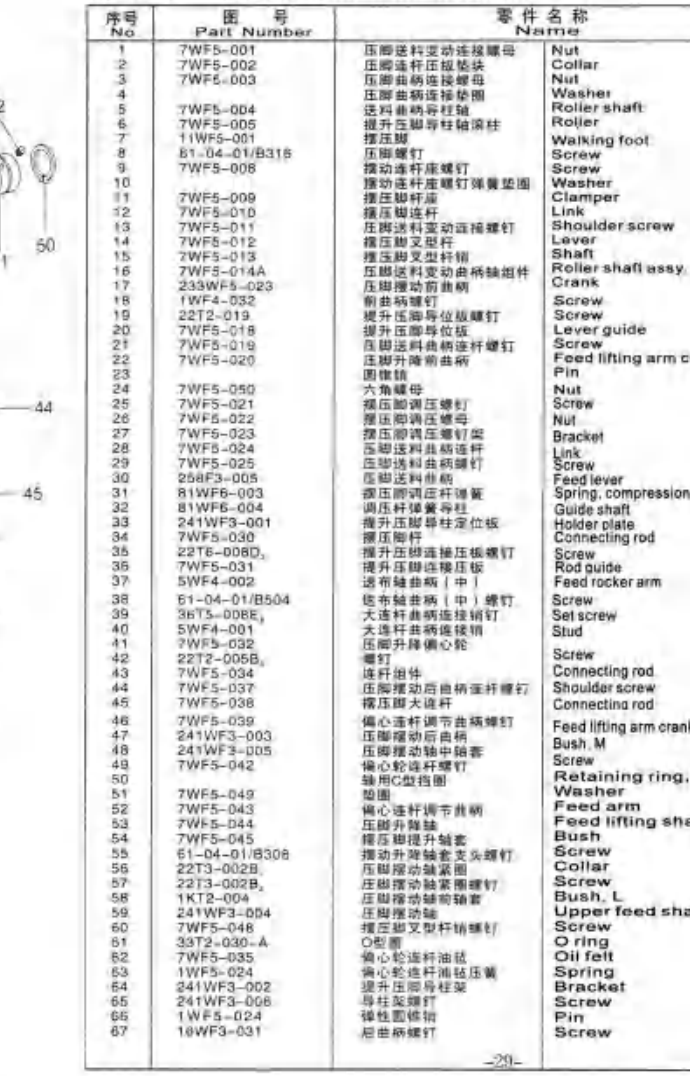

### 8. 剪线部件



### 11. H63-C-TW 专用部件

